

NGD18N45CLB

Ignition IGBT 18 Amps, 450 Volts

N-Channel DPAK

This Logic Level Insulated Gate Bipolar Transistor (IGBT) features monolithic circuitry integrating ESD and Over-Voltage clamped protection for use in inductive coil drivers applications. Primary uses include Ignition, Direct Fuel Injection, or wherever high voltage and high current switching is required.

Features

- Ideal for Coil-on-Plug Applications
- DPAK Package Offers Smaller Footprint for Increased Board Space
- Gate-Emitter ESD Protection
- Temperature Compensated Gate-Collector Voltage Clamp Limits Stress Applied to Load
- Low Threshold Voltage Interfaces Power Loads to Logic or Microprocessor Devices
- Low Saturation Voltage
- High Pulsed Current Capability
- Emitter Ballasting for Short-Circuit Capability
- This is a Pb-Free Device

MAXIMUM RATINGS ($T_J = 25^\circ\text{C}$ unless otherwise noted)

Rating	Symbol	Value	Unit
Collector-Emitter Voltage	V_{CES}	500	V_{DC}
Collector-Gate Voltage	V_{CER}	500	V_{DC}
Gate-Emitter Voltage	V_{GE}	18	V_{DC}
Collector Current-Continuous @ $T_C = 25^\circ\text{C}$ - Pulsed	I_C	18 50	A_{DC} A_{AC}
ESD (Human Body Model) $R = 1500 \Omega$, $C = 100 \text{ pF}$	ESD	8.0	kV
ESD (Machine Model) $R = 0 \Omega$, $C = 200 \text{ pF}$	ESD	400	V
Total Power Dissipation @ $T_C = 25^\circ\text{C}$ Derate above 25°C	P_D	115 0.77	Watts $\text{W}/^\circ\text{C}$
Operating and Storage Temperature Range	T_J, T_{stg}	-55 to +175	$^\circ\text{C}$

Stresses exceeding those listed in the Maximum Ratings table may damage the device. If any of these limits are exceeded, device functionality should not be assumed, damage may occur and reliability may be affected.



Expertise Applied | Answers Delivered

Littelfuse.com

18 AMPS
450 VOLTS
 $V_{CE(on)} \leq 2.1 \text{ V @}$
 $I_C = 10 \text{ A}, V_{GE} \geq 4.5 \text{ V}$

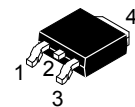
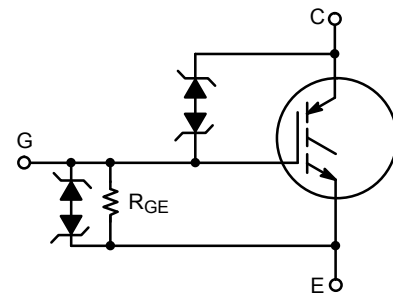

DPAK
CASE 369C
STYLE 7

MARKING DIAGRAM

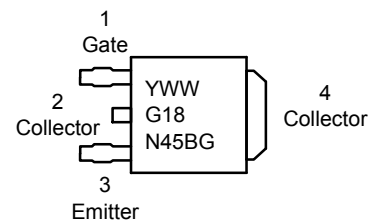

G18N45B = Device Code
Y = Year
WW = Work Week
G = Pb-Free Device

ORDERING INFORMATION

Device	Package	Shipping†
NGD18N45CLBT4G	DPAK (Pb-Free)	2500/Tape & Reel

NGD18N45CLB

UNCLAMPED COLLECTOR-TO-EMITTER AVALANCHE CHARACTERISTICS (Note 2)

Characteristic	Symbol	Value	Unit
Single Pulse Collector-to-Emitter Avalanche Energy	E_{AS}		mJ
$V_{CC} = 50\text{ V}$, $V_{GE} = 5.0\text{ V}$, Pk $I_L = 26.0\text{ A}$, $R_G = 1000\ \Omega$, $L = 1.0\text{ mH}$, Starting $T_J = 25^\circ\text{C}$		338	
$V_{CC} = 50\text{ V}$, $V_{GE} = 5.0\text{ V}$, Pk $I_L = 10.0\text{ A}$, $R_G = 1000\ \Omega$, $L = 8.4\text{ mH}$, Starting $T_J = 25^\circ\text{C}$		420	
$V_{CC} = 50\text{ V}$, $V_{GE} = 5.0\text{ V}$, Pk $I_L = 15.4\text{ A}$, $R_G = 1000\ \Omega$, $L = 2.0\text{ mH}$, Starting $T_J = 150^\circ\text{C}$		237	
$V_{CC} = 50\text{ V}$, $V_{GE} = 5.0\text{ V}$, Pk $I_L = 5.7\text{ A}$, $R_G = 1000\ \Omega$, $L = 15.2\text{ mH}$, Starting $T_J = 150^\circ\text{C}$		247	

MAXIMUM SHORT-CIRCUIT TIMES

Short Circuit Withstand Time – Test 1 (See Figure 17, 3 Pulses with 10 ms Period, $T_a = 105^\circ\text{C}$)	t_{sc1-1}	1000	μs
Short Circuit Withstand Time – Test 1 (See Figure 17, 3 Pulses with 10 ms Period, $T_a = 150^\circ\text{C}$)	t_{sc1-2}	800	μs
Short Circuit Withstand Time – Test 2 (See Figure 18, 3 Pulses with 10 ms Period, $T_a = 105^\circ\text{C}$)	t_{sc2-1}	5	ms
Short Circuit Withstand Time – Test 2 (See Figure 18, 3 Pulses with 10 ms Period, $T_a = 150^\circ\text{C}$)	t_{sc2-2}	1	ms

THERMAL CHARACTERISTICS

Thermal Resistance, Junction to Case	$R_{\theta JC}$	1.3	$^\circ\text{C/W}$
Thermal Resistance, Junction to Ambient	DPAK (Note 1) $R_{\theta JA}$	95	$^\circ\text{C/W}$
Maximum Lead Temperature for Soldering Purposes, 1/8" from case for 5 seconds	T_L	275	$^\circ\text{C}$

ELECTRICAL CHARACTERISTICS

Characteristic	Symbol	Test Conditions	Temperature	Min	Typ	Max	Unit
----------------	--------	-----------------	-------------	-----	-----	-----	------

OFF CHARACTERISTICS (Note 2)

Collector-Emitter Clamp Voltage	BV_{CES}	$I_C = 2.0\text{ mA}$	$T_J = -40^\circ\text{C}$ to 150°C	430	455	470	V_{DC}
		$I_C = 10\text{ mA}$	$T_J = -40^\circ\text{C}$ to 150°C	440	475	500	
Zero Gate Voltage Collector Current	I_{CES}	$V_{CE} = 350\text{ V}$, $V_{GE} = 0\text{ V}$	$T_J = 25^\circ\text{C}$	-	0.5	20	μA_{DC}
			$T_J = 150^\circ\text{C}$	-	75	250	
			$T_J = -40^\circ\text{C}$	-	0.2	10	
		$V_{CE} = 15\text{ V}$, $V_{GE} = 0\text{ V}$	$T_J = 25^\circ\text{C}$	-	-	2.0	
Reverse Collector-Emitter Leakage Current	I_{ECS}	$V_{CE} = -24\text{ V}$	$T_J = 25^\circ\text{C}$	-	0.7	1.0	mA
			$T_J = 150^\circ\text{C}$	-	12	25	
			$T_J = -40^\circ\text{C}$	-	0.1	1.0	
Reverse Collector-Emitter Clamp Voltage	$BV_{CES(R)}$	$I_C = -75\text{ mA}$	$T_J = 25^\circ\text{C}$	24	27	30	V_{DC}
			$T_J = 150^\circ\text{C}$	26	29	33	
			$T_J = -40^\circ\text{C}$	23	26	29	
Gate-Emitter Clamp Voltage	BV_{GES}	$I_G = 5.0\text{ mA}$	$T_J = -40^\circ\text{C}$ to 150°C	11	13	15	V_{DC}
Gate-Emitter Leakage Current	I_{GES}	$V_{GE} = 10\text{ V}$	$T_J = -40^\circ\text{C}$ to 150°C	384	590	700	μA_{DC}
Gate Emitter Resistor	R_{GE}	-	$T_J = -40^\circ\text{C}$ to 150°C	10	16	26	k Ω

1. When surface mounted to an FR4 board using the minimum recommended pad size.

NGD18N45CLB

ELECTRICAL CHARACTERISTICS (continued)

Characteristic	Symbol	Test Conditions	Temperature	Min	Typ	Max	Unit
ON CHARACTERISTICS (Note 2)							
Gate Threshold Voltage	$V_{GE(th)}$	$I_C = 1.0 \text{ mA}$, $V_{GE} = V_{CE}$	$T_J = 25^\circ\text{C}$	1.1	1.56	1.9	V_{DC}
			$T_J = 150^\circ\text{C}$	0.75	1.08	1.4	
			$T_J = -40^\circ\text{C}$	1.2	1.75	2.1	
Collector-to-Emitter On-Voltage	$V_{CE(on)}$	$I_C = 7 \text{ A}$, $V_{GE} = 4.5 \text{ V}$	$T_J = -40^\circ\text{C}$ to 150°C	1.10	1.84	2.30	V
			$T_J = -40^\circ\text{C}$ to 150°C	1.15	1.89	2.35	
			$T_J = -40^\circ\text{C}$ to 150°C	1.20	1.93	2.50	
			$T_J = -40^\circ\text{C}$ to 150°C	1.45	2.07	2.65	
			$T_J = -40^\circ\text{C}$ to 150°C	1.50	2.13	2.80	
			$T_J = -40^\circ\text{C}$ to 150°C	1.55	2.19	2.85	
			$T_J = -40^\circ\text{C}$ to 150°C	-	0.65	1.00	
Threshold Temperature Coefficient (Negative)	-	-	-	-	3.5	-	mV/°C
Forward Transconductance	gfs	$V_{CE} = 5.0 \text{ V}$, $I_C = 6.0 \text{ A}$	$T_J = -40^\circ\text{C}$ to 150°C	6.0	14	25	Mhos

DYNAMIC CHARACTERISTICS (Note 2)

Input Capacitance	C_{ISS}	$V_{CC} = 25 \text{ V}$, $V_{GE} = 0 \text{ V}$ $f = 1.0 \text{ MHz}$	$T_J = -40^\circ\text{C}$ to 150°C	400	780	1000	pF
Output Capacitance	C_{OSS}			50	72	100	
Transfer Capacitance	C_{RSS}			4.0	6	10	

SWITCHING CHARACTERISTICS (Note 2)

Turn-Off Delay Time	$t_{d(off)}$	$V_{CC} = 300 \text{ V}$, $V_{GE} = 5 \text{ V}$ $R_G = 1.0 \text{ k}\Omega$, $R_L = 46 \Omega$,	$T_J = 25^\circ\text{C}$	1.0	2.9	12	μSec
Fall Time	t_f	$V_{CC} = 300 \text{ V}$, $V_{GE} = 5 \text{ V}$ $R_G = 1.0 \text{ k}\Omega$, $R_L = 46 \Omega$,	$T_J = 25^\circ\text{C}$	1.0	2.5	7.0	
Turn-On Delay Time	$t_{d(on)}$	$V_{CC} = 14 \text{ V}$, $V_{GE} = 5 \text{ V}$ $R_G = 1.0 \text{ k}\Omega$, $R_L = 1 \Omega$	$T_J = 25^\circ\text{C}$	0.1	0.42	1.4	μSec
Rise Time	t_r	$V_{CC} = 14 \text{ V}$, $V_{GE} = 5 \text{ V}$ $R_G = 1.0 \text{ k}\Omega$, $R_L = 1 \Omega$	$T_J = 25^\circ\text{C}$	1.0	2.5	9.0	

2. Electrical Characteristics at temperature other than 25°C, Dynamic and Switching characteristics are not subject to production testing. Product parametric performance is indicated in the Electrical Characteristics for the listed test conditions, unless otherwise noted. Product performance may not be indicated by the Electrical Characteristics if operated under different conditions.

NGD18N45CLB

TYPICAL ELECTRICAL CHARACTERISTICS (unless otherwise noted)

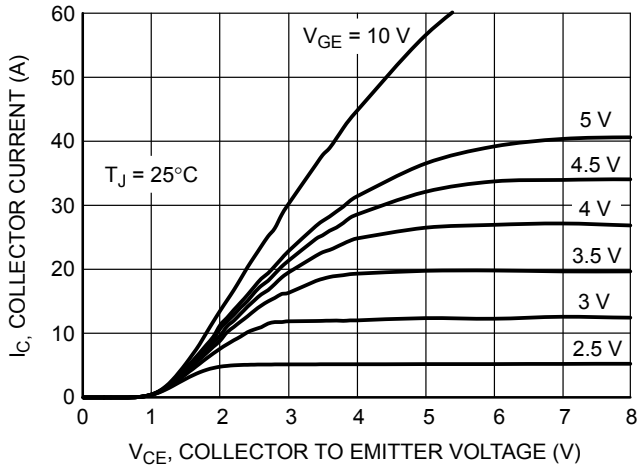

Figure 1. Output Characteristics

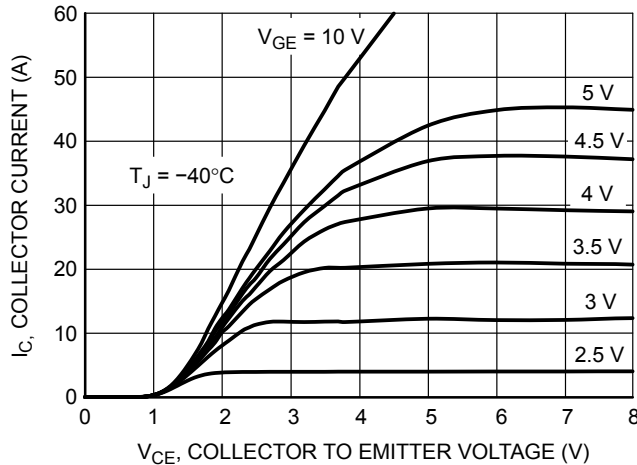

Figure 2. Output Characteristics

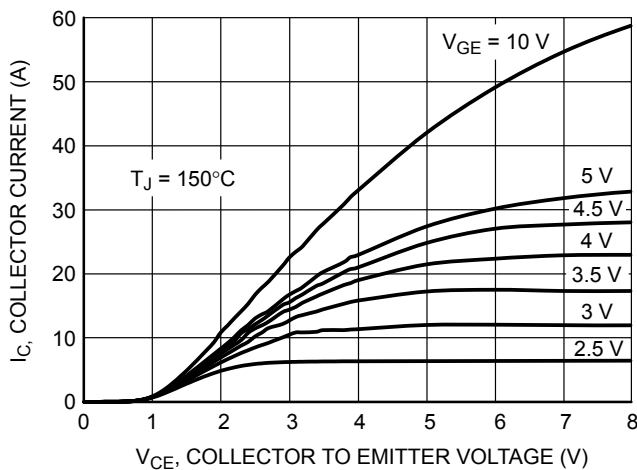

Figure 3. Output Characteristics

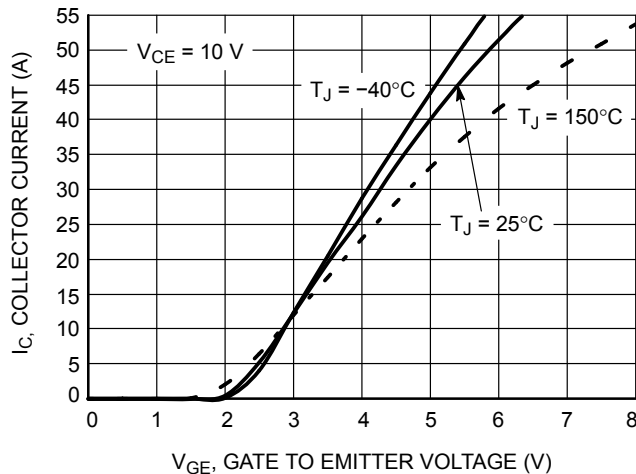

Figure 4. Transfer Characteristics

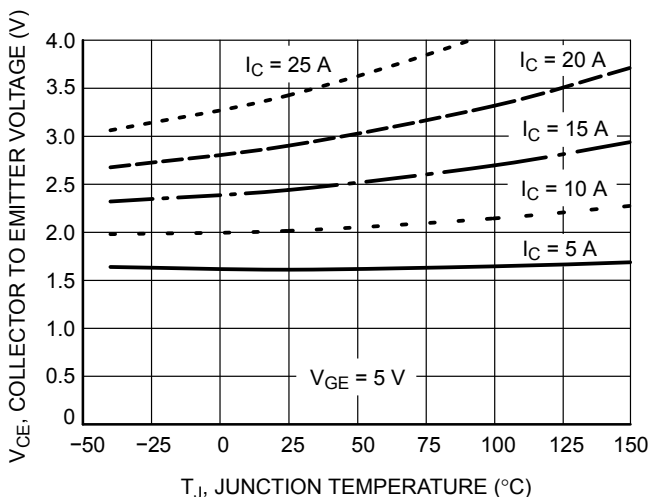

Figure 5. Collector-to-Emitter Saturation Voltage vs. Junction Temperature

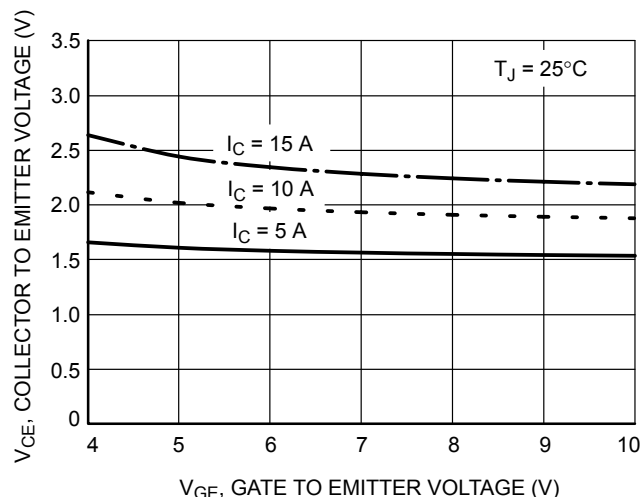

Figure 6. Collector-to-Emitter Voltage vs. Gate-to-Emitter Voltage

NGD18N45CLB

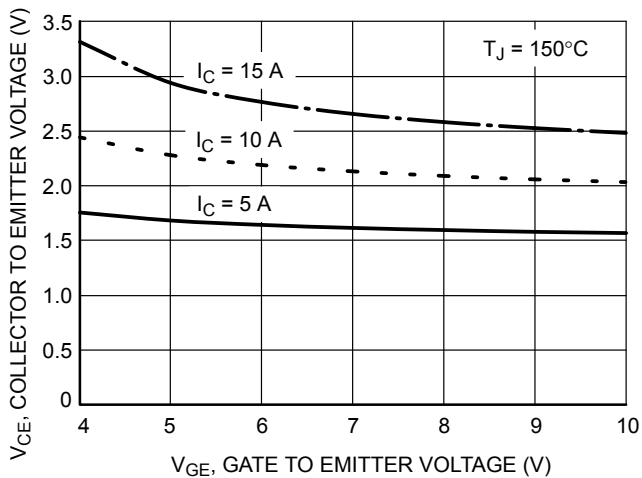

Figure 7. Collector-to-Emitter Voltage vs. Gate-to-Emitter Voltage

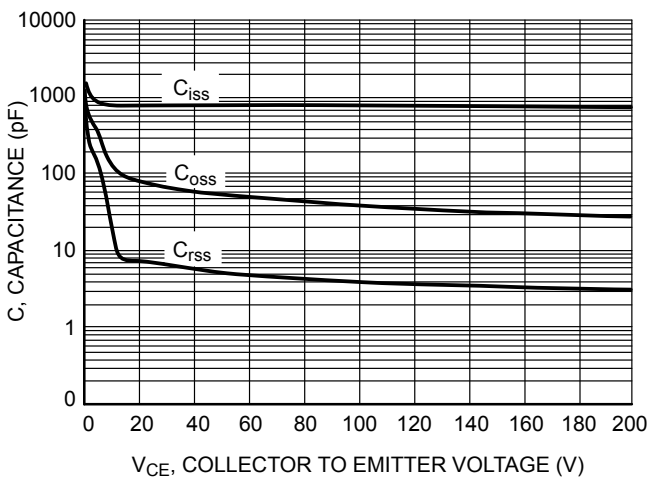

Figure 8. Capacitance Variation

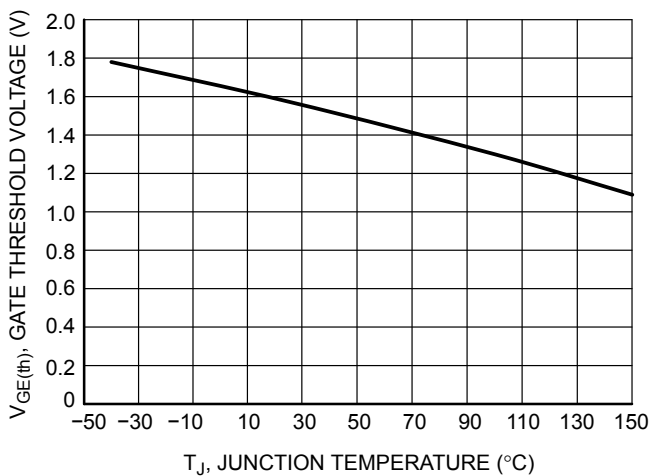

Figure 9. Gate Threshold Voltage vs. Junction Temperature

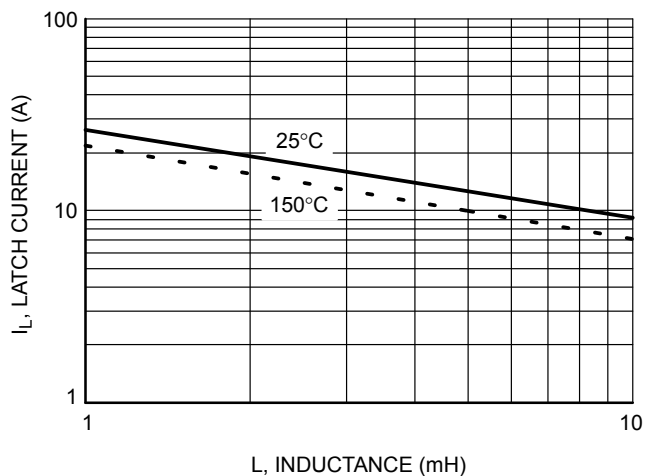

Figure 10. Minimum Open Secondary Latch Current vs. Inductance

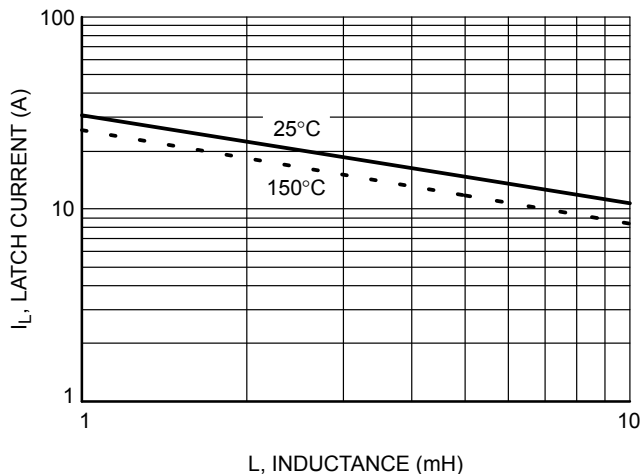

Figure 11. Typical Open Secondary Latch Current vs. Inductance

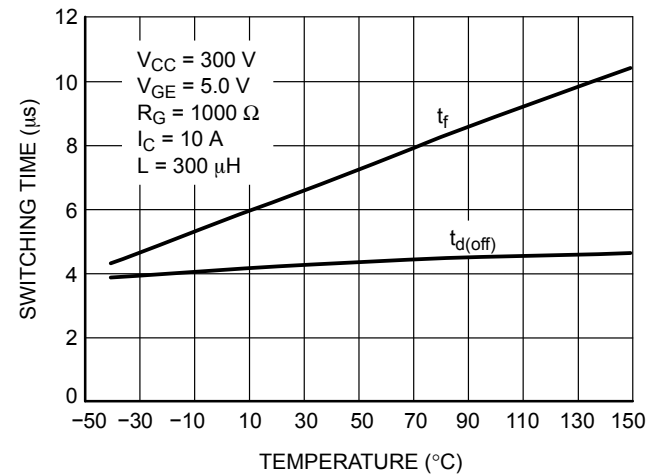

Figure 12. Inductive Switching Fall Time vs. Temperature

NGD18N45CLB

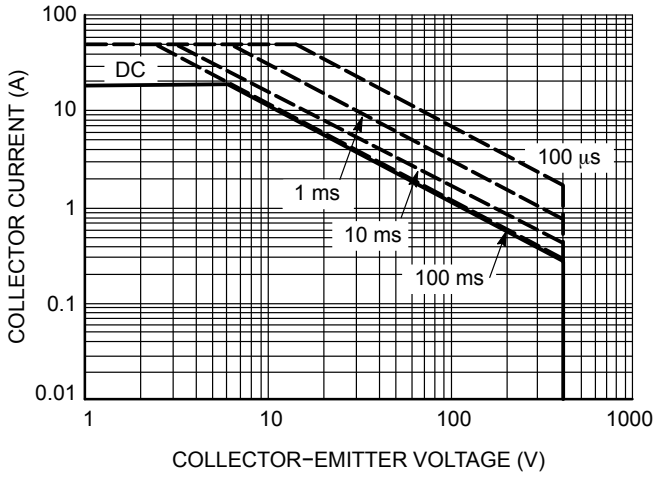

Figure 13. Single Pulse Safe Operating Area (Mounted on an Infinite Heatsink at $T_A = 25^\circ\text{C}$)

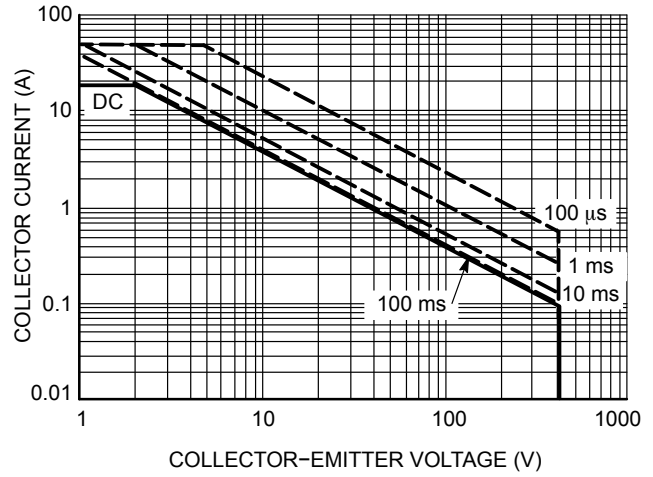

Figure 14. Single Pulse Safe Operating Area (Mounted on an Infinite Heatsink at $T_A = 125^\circ\text{C}$)

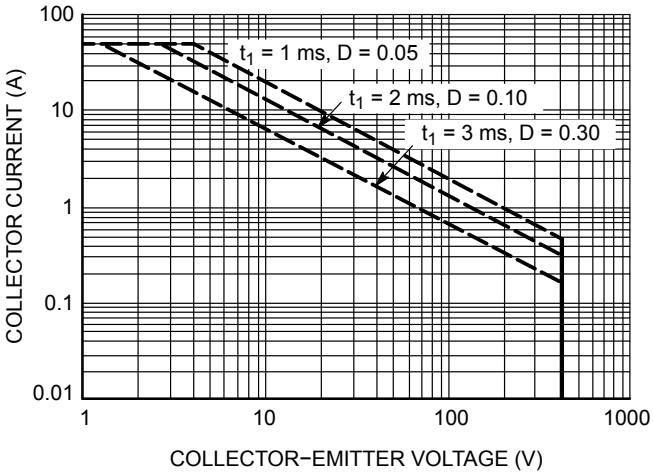

Figure 15. Pulse Train Safe Operating Area (Mounted on an Infinite Heatsink at $T_C = 25^\circ\text{C}$)

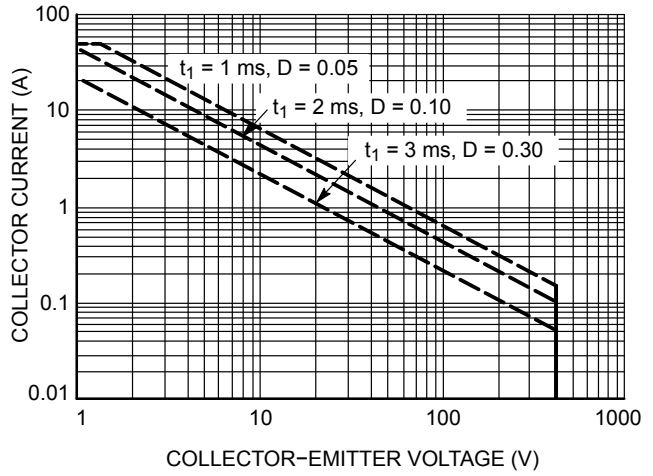

Figure 16. Pulse Train Safe Operating Area (Mounted on an Infinite Heatsink at $T_C = 125^\circ\text{C}$)

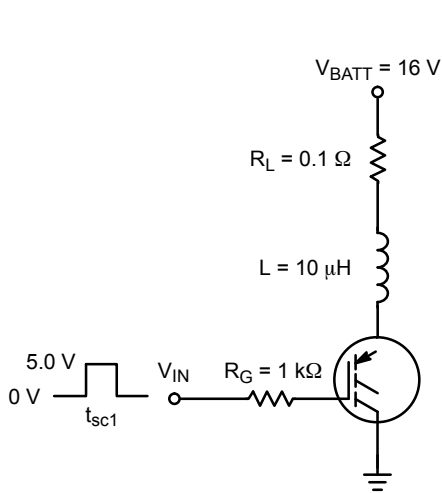

Figure 17. Circuit Configuration for Short Circuit Test #1

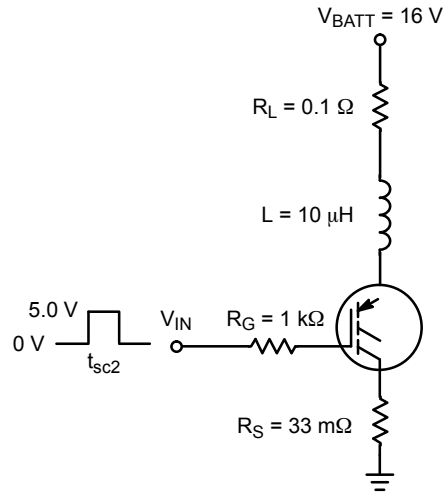
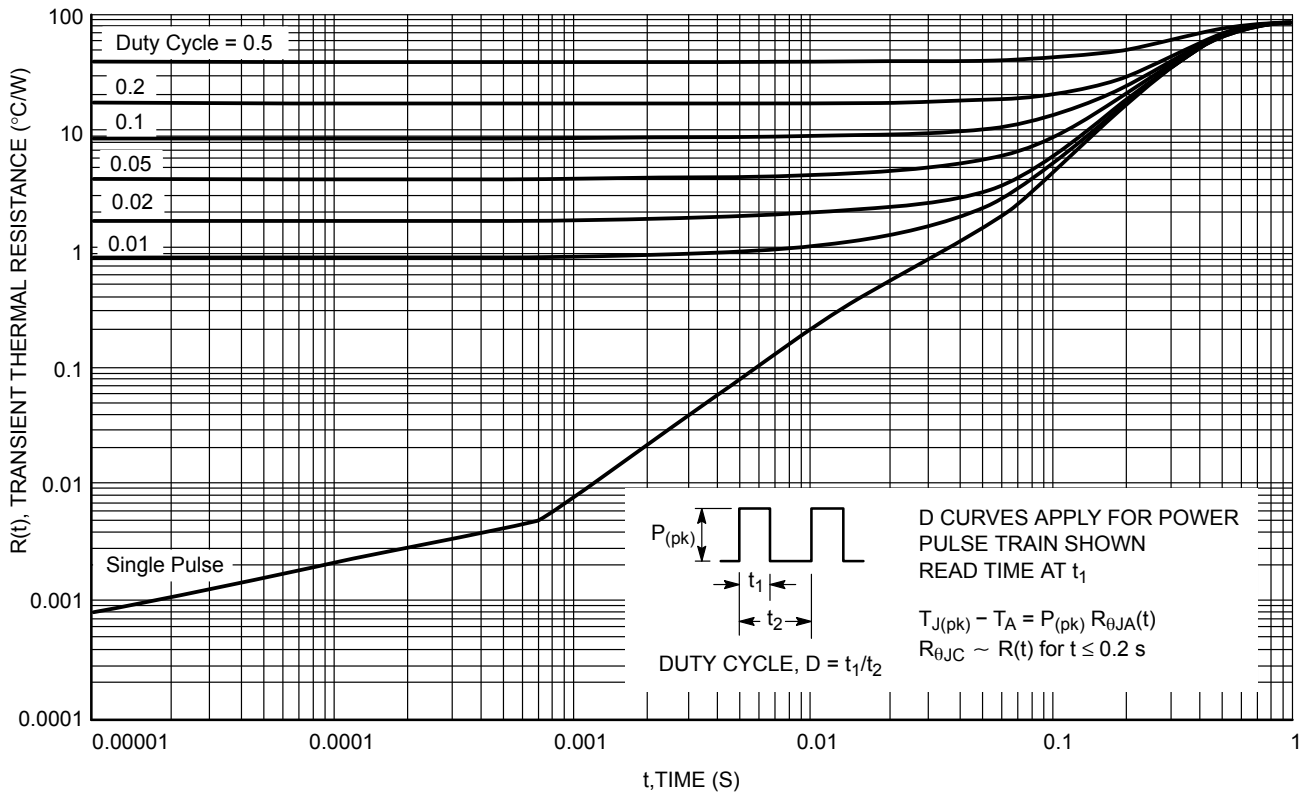

Figure 18. Circuit Configuration for Short Circuit Test #2

NGD18N45CLB

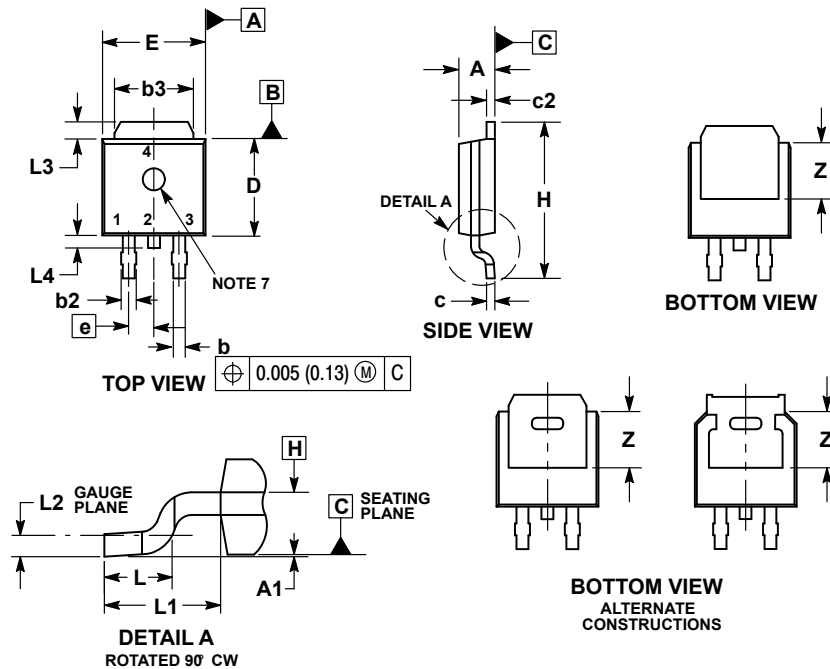

**Figure 19. Transient Thermal Resistance
(Non-normalized Junction-to-Ambient mounted on minimum pad area)**

NGD18N45CLB

PACKAGE DIMENSIONS

DPAK (SINGLE GAUGE) CASE 369C ISSUE F



NOTES:

1. DIMENSIONING AND TOLERANCING PER ASME Y14.5M, 1994.
2. CONTROLLING DIMENSION: INCHES.
3. THERMAL PAD CONTOUR OPTIONAL WITHIN DIMENSIONS b3, L3 and Z.
4. DIMENSIONS D AND E DO NOT INCLUDE MOLD FLASH, PROTRUSIONS, OR BURRS. MOLD FLASH, PROTRUSIONS, OR GATE BURRS SHALL NOT EXCEED 0.006 INCHES PER SIDE.
5. DIMENSIONS D AND E ARE DETERMINED AT THE OUTERMOST EXTREMES OF THE PLASTIC BODY.
6. DATUMS A AND B ARE DETERMINED AT DATUM PLANE H.
7. OPTIONAL MOLD FEATURE.

DIM	INCHES		MILLIMETERS	
	MIN	MAX	MIN	MAX
A	0.086	0.094	2.18	2.38
A1	0.000	0.005	0.00	0.13
b	0.025	0.035	0.63	0.89
b2	0.028	0.045	0.72	1.14
b3	0.180	0.215	4.57	5.46
c	0.018	0.024	0.46	0.61
c2	0.018	0.024	0.46	0.61
D	0.235	0.245	5.97	6.22
E	0.250	0.265	6.35	6.73
e	0.090 BSC		2.29 BSC	
H	0.370	0.410	9.40	10.41
L	0.055	0.070	1.40	1.78
L1	0.114 REF		2.90 REF	
L2	0.020 BSC		0.51 BSC	
L3	0.035	0.050	0.89	1.27
L4	---	0.040	---	1.01
Z	0.155	---	3.93	---

STYLE 7:

- PIN 1. GATE
- COLLECTOR
- EMITTER
- COLLECTOR

SOLDERING FOOTPRINT*

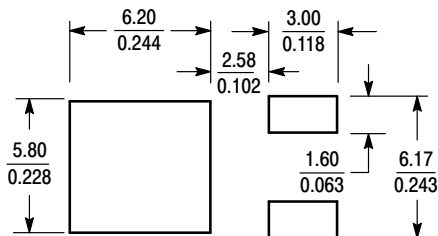

SCALE 3:1 $\left(\frac{\text{mm}}{\text{inches}}\right)$

Information furnished is believed to be accurate and reliable. However, users should independently evaluate the suitability of and test each product selected for their own applications. Littelfuse products are not designed for, and shall not be used for, any purpose (including, without limitation, military, aerospace, medical, life-saving, life-sustaining or nuclear facility applications, devices intended for surgical implant into the body, or any other application in which the failure or lack of desired operation of the product may result in personal injury, death, or property damage) other than those expressly set forth in applicable Littelfuse product documentation. Warranties granted by Littelfuse shall be deemed void for products used for any purpose not expressly set forth in applicable Littelfuse documentation. Littelfuse shall not be liable for any claims or damages arising out of products used in applications not expressly intended by Littelfuse as set forth in applicable Littelfuse documentation. The sale and use of Littelfuse products is subject to Littelfuse Terms and Conditions of Sale, unless otherwise agreed by Littelfuse.

Littelfuse.com

Mouser Electronics

Authorized Distributor

Click to View Pricing, Inventory, Delivery & Lifecycle Information:

[Littelfuse:](#)

[NGD18N45CLBT4G](#)